



METAL ROOF & WALL SYSTEMS

2019 CATALOG



Table Of Contents

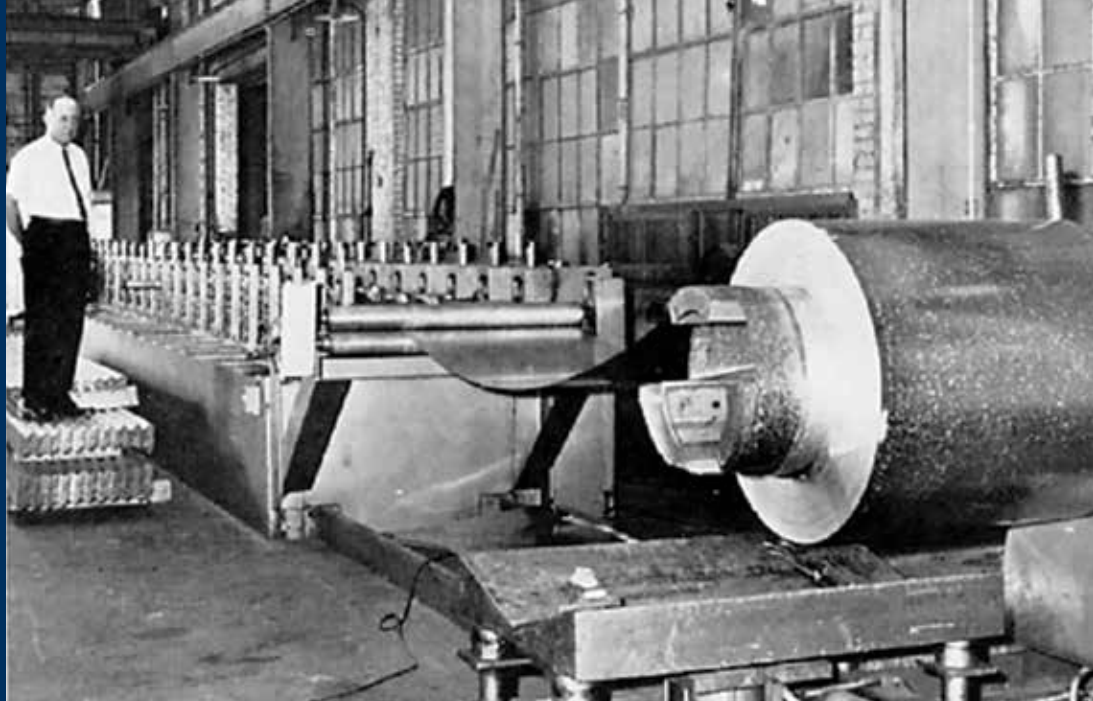

Thomas E. McElroy Sr. (Mr. Mac) in 1963 posing with the company's first rollformer.



From humble beginnings in 1963, McElroy Metal has grown into a national company with 13 manufacturing and 23 Service Center locations across the United States. McElroy Metal is a third generation family-owned business with a strong culture of values that extends to customers, employees, and vendors.

Contents

McElroy Information & Resources	inside front cover
Location Map	1
Standing Seam Systems	
Maxima	Roof 2-3
138T & 238T Panel	Roof 4-5
138T & 238T Recover	Roof 7
Medallion-Lok	Roof 9
Meridian	Roof 11
Instaloc	Roof 11
Medallion I	Roof 13
Medallion II	Roof 13
Mirage	Roof 14
Mirage II	Roof 14
MasterLok-90	Roof 15
MasterLok-FS	Roof 15

Soffit / Fascia & Canopy	
FW Series	Soffit 16
MCP	Canopy 16
Matrix	Soffit 17
Marquee-Lok	Soffit/Fascia/Wall 17
Marquee II	Soffit/Fascia/Wall 17
Concealed Fastener Panels	
Wave	Wall 19
MSR	Wall 19
Exposed Fastener	
Mega-Rib	Roof & Wall 21
Multi-Cor & M-Cor	Roof & Wall 21
Max-Rib	Roof & Wall 23
Mesa	Roof & Wall 23
5V	Roof & Wall 23
U-Panel	Roof & Wall 23

R-Panel	Roof & Wall 25
Multi-Rib	Roof & Wall 25
Mini-Rib	Wall, Fascia, Liner ... 25
Multi-V	Wall 25
Specialty Panels	
Met-Tile 27
Milan 27

Retrofit Roofing Systems 29

Solar Solutions 31

Green Span Profiles

Insulated Metal Panels	inside back cover
Slit Coil and Flat Sheets	back cover

Contact:

info@mcelroymetal.com
www.mcelroymetal.com

Corporate Office:

1500 Hamilton RD.
Bossier City, LA 71111

Manufacturing Facility Locations

California, **Adelanto**
Georgia, **Ashburn**
Georgia, **Peachtree City**
Illinois, **Clinton**
Kentucky, **Lewisport**
Louisiana, **Bossier City**
Michigan, **Marshall**
Missouri, **Diamond**
Texas, **Houston**
Texas, **Merkel**
Texas, **Sunnyvale**
Virginia, **Winchester**
Wisconsin, **Mauston**

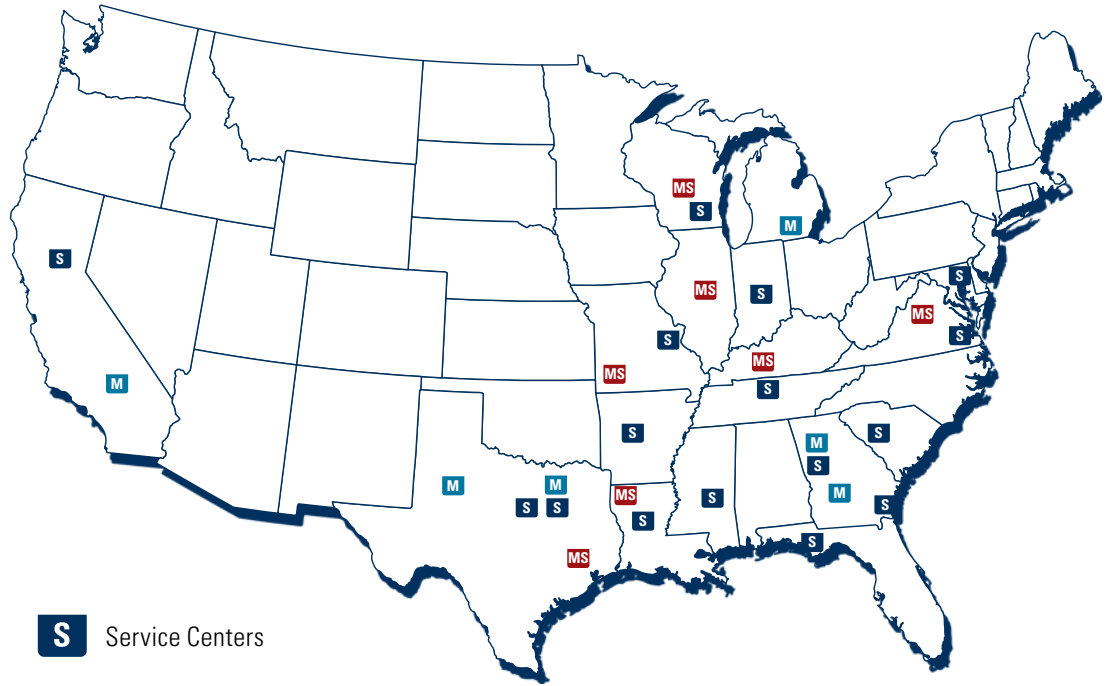

- S** Service Centers
- M** Manufacturing Facilities
- MS** Both Manufacturing Facilities & Service Centers

For more information:

Light Gauge/Post Frame/
Residential Customer Service:
800-950-6534
LightGaugeCS@mcelroymetal.com

Commercial/Residential
Customer Service:
800-950-6531
CommercialCS@mcelroymetal.com

Architectural Customer Service:
800-950-6533
ArchCS@mcelroymetal.com

Western Region Customer Service -
All Products and Markets (CA, AZ, UT,
NV, WA, OR, AK, ID, MT, and WY):
800-950-6536
WesternCS@mcelroymetal.com

General Information:
318-747-8000

Marketing Department:
800-562-3576

Proud member of these
leading organizations:

Service Center Locations

8304 Highway 70 E.
North Little Rock, AR 72117
Phone: 800-950-6539

8200 Berry Ave. Suite 100
Sacramento, CA 95826
Phone: 800-950-8448

409 Lovejoy Road
Ft. Walton Beach, FL 32548
Phone: 800-950-6026

1365 Dean Forest Rd.
Savannah, GA 31405
Phone: 800-342-2764

7355 Oakley Industrial Blvd
Union City, GA 30291
Phone: 855-251-2577

9476 Meadowbrook Rd.
Clinton, IL 61727
Phone: 877-808-7994

10504 E. 59th Street
Indianapolis, IN 46236
Phone: 866-595-1343

9435 US Highway 60 West
Lewisport, KY 42351
Phone: 800-844-3724

5215 Leo Street
Alexandria, LA 71301
Phone: 888-767-0087

1500 Hamilton Rd
Bossier City, LA 71111
Phone: 888-245-3696

1007 Wilso Drive
Baltimore, MD 21223
Phone: 844-257-5310

3215 Highway 59
Diamond, MO 64840
Phone: 866-325-7200

390 N. Valley Dell Dr.
Fenton, MO 63026
Phone: 888-673-0920

613 N. Bierdeman Rd.
Pearl, MS 39209
Phone: 800-704-7159

1144 Silstar Road
West Columbia, SC 29170
Phone: 866-494-5316

514 Cave Road
Nashville, TN 37210
Phone: 855-884-0978

3014 Lincoln Court
Garland, TX 75041
Phone: 877-742-8675

1440 Aldine Bender Road
Houston, TX 77032
Phone: 855-885-7600

7450 Tower Street
Richland Hills, TX 76118
Phone: 817-595-7490

3052 Yadkin
Chesapeake, VA 23323
Phone: 888-286-6334

325 McGhee Road
Winchester, VA 22603
Phone: 844-437-2887

1020 Veterans Street
Mauston, WI 53948
Phone: 888-972-4911

5123 Terminal Drive
McFarland, WI 53558
Phone: 800-988-0921



Standing Seam Systems



	WIDTH	PAN CONDITIONS						FACTORY NOTCHING			SEAM	
	WIDTH IN INCHES	STRIATED	MINOR RIBS	SINGLE PENCIL RIB	DOUBLE PENCIL RIB	FLAT PAN	CURVED	LAP	EAVE	NONE	90 DEGREE SEAM	180 DEGREE SEAM
MAXIMA PROFILES												
Maxima 1.5"	12	■		■		■	■			■		■
Maxima 1.5"	16, 18	■			■	■	■			■		■
Maxima 2"	12	■		■		■		■	■	■	■	
Maxima 2"	16, 18	■			■	■		■	■	■	■	
Maxima ADV 2"	12	■		■		■	■	■	■	■		■
Maxima ADV 2"	16, 18	■			■	■	■	■	■	■		■
Maxima 3" Minor Rib (Std.) 18" panel only available with one minor rib	18, 24	■	■					■	■	■	■	

Curving Details

- Only Maxima 1.5 and Maxima ADV can be curved
- Minimum radius:
25' for 2" ADV
12' for 1.5"
- 180° seam required
- Sealant to be field applied on curved applications
- Maxima ADV and Maxima 1.5 flat panels will curve naturally on a radius of 250 feet or greater

Maxima

Offering strength, durability and aesthetics, vertical leg standing seam systems are the industry's most popular roofing panel. To meet the varying needs of specifiers and contractors, McElroy Metal's Maxima line represents the industry's broadest selection of vertical leg systems:

- Seam heights of 1.5", 2" & 3"
- Varying pan widths
- 90° & 180° seams
- Available flat or curved



Maxima 1.5"

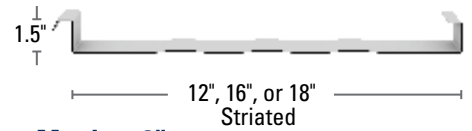

Maxima 2"

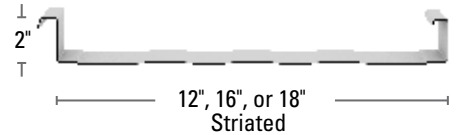

Maxima ADV

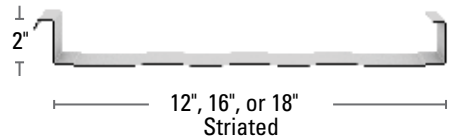

Note: Maxima ADV also available without shoulders.

Maxima 3"

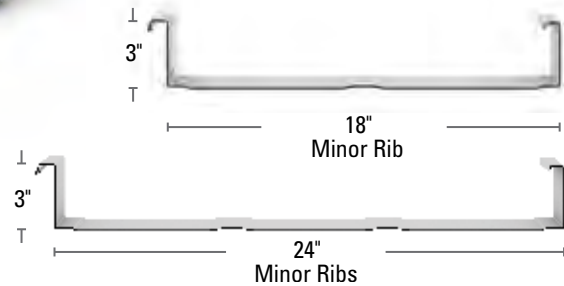

Note: Maxima 2" and 3" panels feature a return leg on both the male and female seams. These return legs help create greater strength and uplift capabilities. Maxima 1.5 and ADV do not feature the return legs, which enables the panels to be curved as well as seamed to 180 degrees.

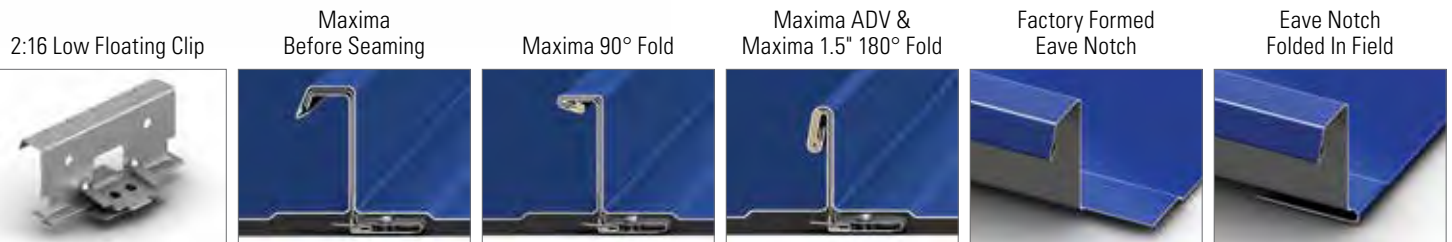

Note: Patented Floating Clips allow for 3 1/8" of thermal movement

Details

- Mechanically seamed profile
- Factory formed eave notch upon request
- Factory applied sealant (on non-curved panels only)
- Minimum slope: 1:12 for 1.5"
- Minimum slope: 1/2:12 for 2"
- Minimum slope: 1/4:12 for 3"
- Can be installed over solid deck or open framing
- Maxima 2" and ADV also available jobsite formed for long lengths
- Floating clips allow for 3 1/8" thermal movement

Panel Options

- Panel height & width: See panel profile drawings above
- Panel configurations: See chart on left
- Coating: Kynar 500® (PVDF)
- Substrate:
 - Standard 24 gauge Galvalume®
 - Optional 22 gauge Galvalume
 - .032 and .040 aluminum (Aluminum is produced at the Sunnyvale, TX facility only. No testing available on aluminium)

Testing Data

- Fire Rating: Class A
- Uplift Test: UL580 Class 90 FM 4471 for 2" only (1-90 Rated) ASTM E1592 for 1.5", 2" & 3"
- Air Infiltration: ASTM E1680
- Water Infiltration: ASTM E1646
- Class 4 Impact Resistance: UL 2218

- Florida State Approval: 1747.3 (2" & 3") 1832.4 (2" & 3")
- Fire Resistance: UL 263
- Miami-Dade Approval: (216 only) NOA#17-0320.04
- ICC-ES Approval: ESL-1082
- All testing conducted with Galvalume substrate
- For any available Test Data, Section Properties or Load Tables, please visit our download section at www.mcelroymetal.com

Oil canning (pan wave) is a natural occurrence in metal panels and is not a cause for panel rejection.

Standing Seam Systems



Jobsite Production Vehicles

Available for:

- Maxima 2"
- Maxima ADV
- 138T & 238T

138T & 238T

138T & 238T symmetrical standing seam systems offer many advantages over popular asymmetrical panels. 138T and 238T panels do not have male and female seams. Rather, these panels have identical left and right seams. Panels are then joined with a mechanically seamed cap.

- Ease of installation
- Available flat, curved, and tapered
- Individual panel replacement
- Watertight seam design
- Can be jobsite formed for longer lengths
- No laps equals greater watertightness

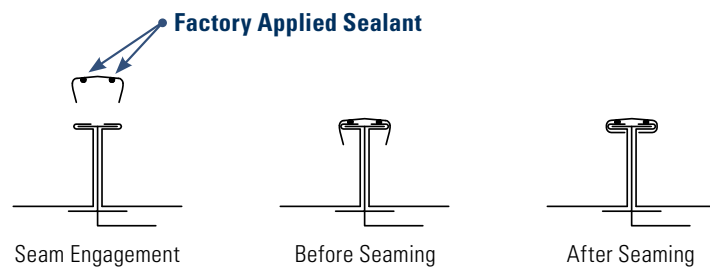

138T & 238T Panel

138T Panel Options

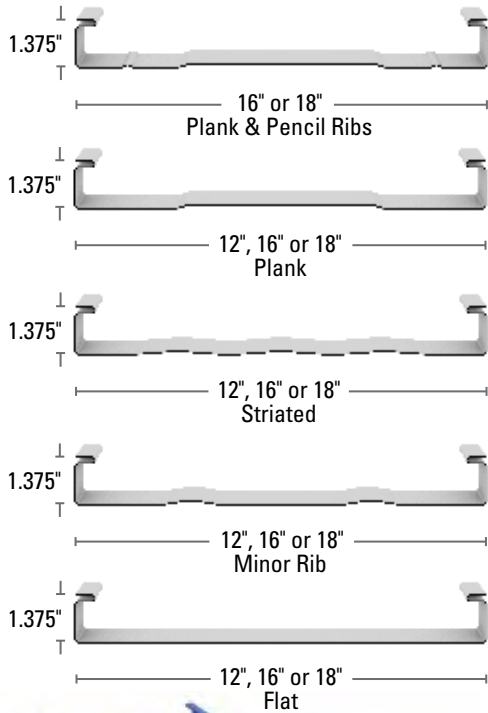

238T Panel Options

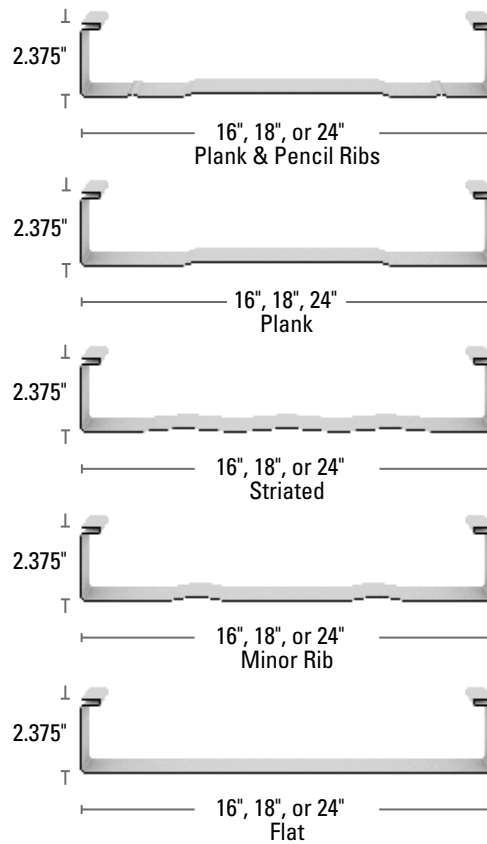

138T Clip



238T Clip



138T and 238T Two Piece Multi-Span Clip (238T Shown)



138T and 238T Two Piece Multi-Span Clip as Installed (238T Shown)

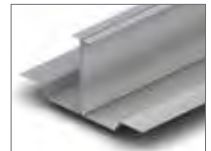

138T Details

- Mechanically seamed
- Minimum slope: 2:12
- Must be installed over solid deck

Panel Options

- 138T panel width: 12", 16", 18"
- Panel configurations:
 - 138T (16" & 18"): flat, striated, plank & pencil ribs, plank, minor ribs (plank & pencil rib recommended)
 - 138T (12"): flat, striated, minor ribs, plank (plank recommended)
- Coating: Kynar 500® (PVDF)
- Substrate:
 - Standard 24 gauge Galvalume®
 - Optional 22 gauge Galvalume
 - .032 and .040 aluminum
 - Optional 16 oz and 20 oz copper (Houston plant only)
- 138T manufacturing: factory, jobsite roll-formed, curved on-site

Testing Data

- Fire Rating: UL Class A
- Uplift Test: UL580 Class 90, UL 1897, ASTM E1592
- Impact Resistance: UL Class 4
- For any available Test Data, Section Properties or Load Tables, please visit our download section at www.mcelroymetal.com

238T Details

- Mechanically seamed
- Minimum slope: 1/2:12
- 238T subject to prior approval, 1/4:12 may be acceptable
- Can be installed over solid deck or open framing

Panel Options

- 238T panel width: 16", 18", 24" (24" panel formed on-site only)
- Panel configurations:
 - 238T: flat (16" & 18" only), striated, plank & pencil ribs, plank, minor ribs (plank & pencil ribs recommended)
- Coating: Kynar 500® (PVDF)
- Substrate:
 - Standard 24 gauge Galvalume®
 - Optional 22 gauge Galvalume
 - .032 and .040 aluminum
 - Optional 16 oz and 20 oz copper (Houston plant only)
- 238T manufacturing: factory, jobsite roll-formed, curved on-site

Testing Data

- Fire Rating: UL Class A
- Uplift Test: UL580 Class 90, UL 1897, FM 4471, ASTM E1592
- Air & Water Infiltration: ASTM E1680, ASTM E1646
- Impact Resistance: UL Class 4
- Static Water: FM 4471 Appendix G, ASTM E2140
- Texas Department of Insurance Approval: RC-270 (238T only)
- Florida State Approval: 16606.1, 16606.2, 16606.3
- Miami Dade Approval: NOA # 15-1216.03
- ICC-ES Approval: ESL-1082
- FM Class 1-SH
- For any available Test Data, Section Properties or Load Tables, please visit our download section at www.mcelroymetal.com

Standing Seam Recover Systems

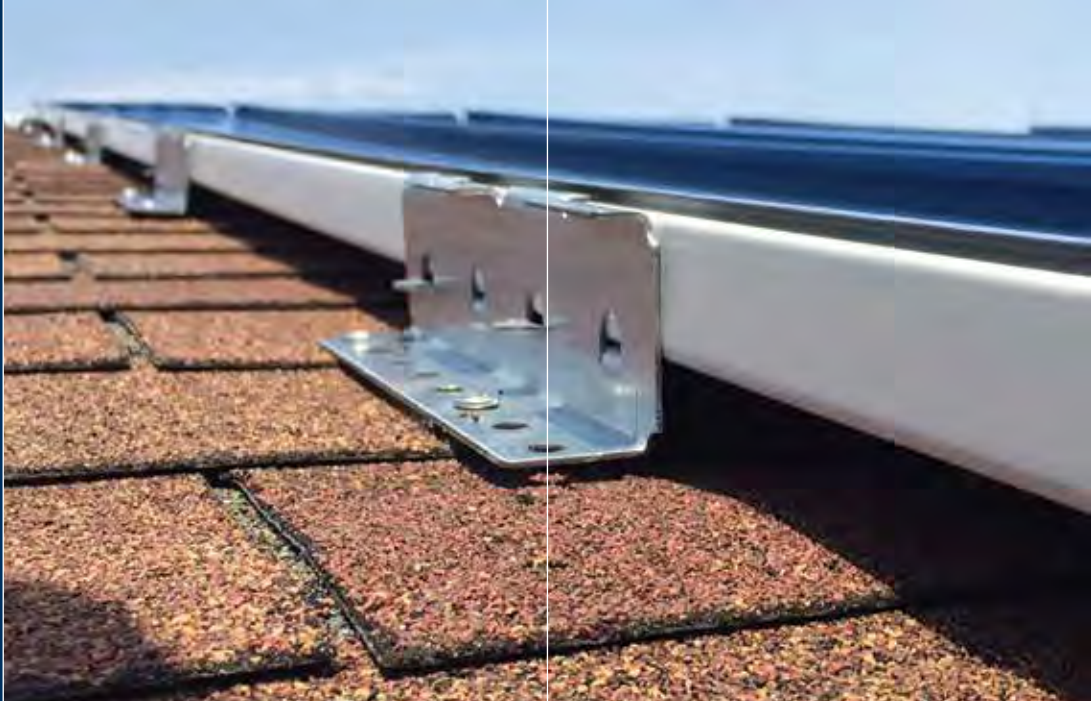

138T Shingle Recover System

Featuring McElroy's 138T symmetrical standing seam panel, this innovative system installs directly over existing shingles without tear-off or underlayment.

- Ease of installation
- Above sheathing ventilation (ASV) - Utilizing air space to help reduce heat transfer and decrease energy expense)
- No tear off/disposal of existing roof
- No underlayment required
- Individual panel replaceability
- Decades long service life



4" ASV clip

8" shingle recover clip with ASV

Note: 4" ASV clip for new construction or remove and replace.



Corrugated sheeting installed at the ridge allows for continuous air flow between the existing and new roof while providing support for the panel and closure. Free flowing air space between a metal roof and shingles can reduce heat transfer.



The key to a proper installation of a standing seam recover over shingles is the patented shingle recover clip which is long enough to sit on two shingles simultaneously.

238T Metal-Over-Metal System

McElroy Metal's patented 238T frameless metal-over-metal recover solutions provide low cost retrofit solutions over both existing exposed fastened and 3" tall trapezoidal standing seam systems.

- Two patented frameless recover systems
- Job site production enables eave to ridge panels
- Extremely high wind uplift capacity without additional edge zone or corner framing
- 24" wide panels reduce installation labor
- Individual panel removal and replacement
- Decades long service life

Seaming

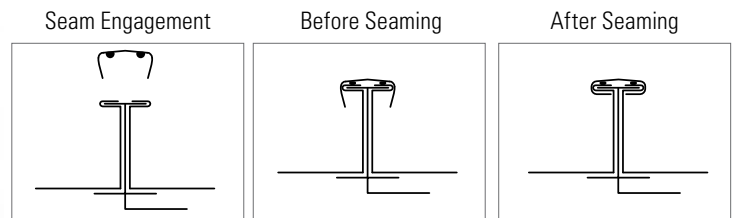

Die-cut foam insulation is placed over the existing roof panels and the 238T panels are placed on top of the insulation. The 238T panels are then joined together using 238T caps and a mechanical seamer.



Single length panels offer labor savings and improve weathertightness.

Standing Seam Systems



Medallion-Lok

Medallion-Lok is a snap-together architectural panel with structural capabilities that features a rigid 1.75" standing seam. Medallion-Lok is McElroy Metal's most popular snap-together panel and has been utilized to add beauty and function on projects all across the country.

Panel Options

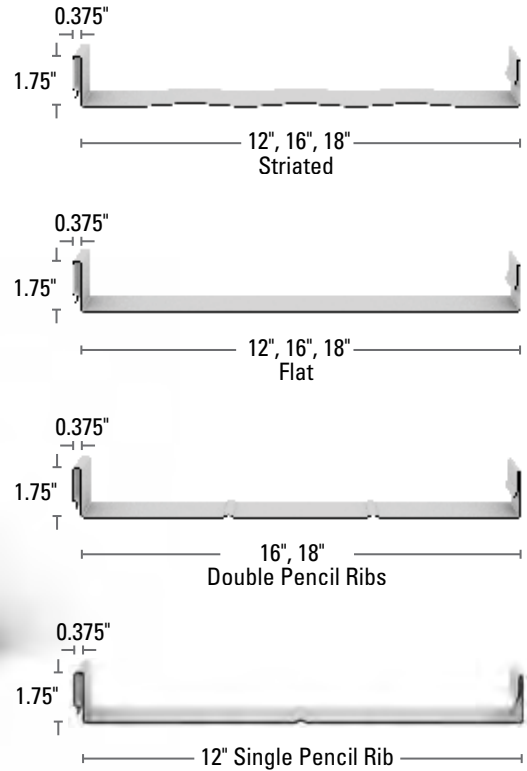

Note: Striated panels are recommended as they reduce the appearance of oil canning

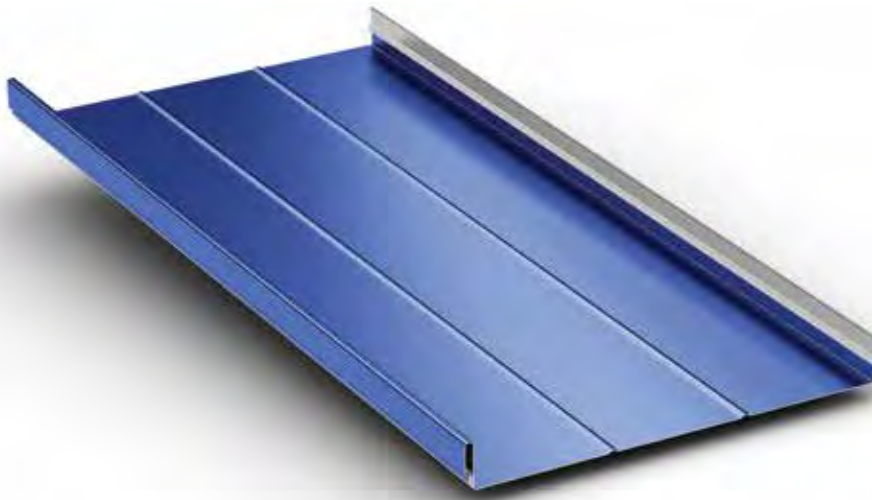

Standard Clip



UL 90 Clip



Seam Detail



Factory Eave Notch



Eave Notch
Folded In Field



Details

- Factory formed eave notch upon request in: Clinton, Peachtree City, and Sunnyvale
- Factory applied sealant
- Minimum slope: 3:12
- Can be installed over solid deck or open framing

Panel Options

- Panel width 12", 16" & 18"
- Panel configurations: striated, ribbed or flat pan (striated recommended)
- Coating: Kynar 500® (PVDF)
- Substrate:
 - Standard 24 gauge Galvalume®
 - Optional 22 gauge Galvalume
 - .032 and .040 aluminum

Testing Data

- Fire Rating: Class A
- Uplift Test: UL580 Class 90 ASTM E1592
- Air Infiltration: ASTM E1680
- Water Infiltration: ASTM E1646
- Class 4 Impact Resistance: UL 2218
- Florida State Approval: 1747.5 and 1832.7
- Fire Resistance: UL 263
- Miami Dade Approval: NOA#13-0430.06
- ICC-ES Approval: ESL-1082
- For any available Test Data, Section Properties or Load Tables, please visit our download section at www.mcelroymetal.com

Standing Seam Systems



Meridian

Meridian is an economical, snap-together roofing system that is an excellent choice for commercial and residential applications. Panels are simply installed by placing pancake head fasteners in the panel's slotted flange. Meridian is installed over solid deck.

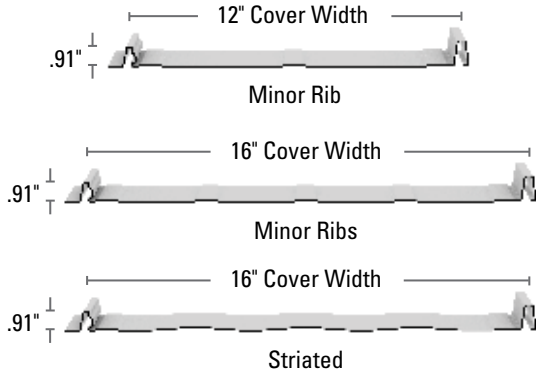

Seam Detail

Factory Eave Notch

Eave Notch
Folded In Field

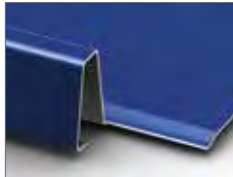

Details

- Factory formed eave notch upon request
- Minimum slope: 3:12
- Must be installed over solid deck

Panel Options

- Panel width: 12" and 16"
- Panel configurations: 16" minor ribs or striated, 12" minor ribs or striated
- Coating: Kynar 500® (PVDF)
- Substrate:
 - Standard 26 gauge Galvalume® for 16" panels only
 - Standard 24 gauge Galvalume for 12" and 16" panels

Testing Data

- Fire Rating: Class A
- Air Infiltration: ASTM E1680
- Water Infiltration: ASTM E1646
- Class 4 Impact Resistance: UL 2218
- Texas Department of Insurance Approval: Evaluation RC-34
- Florida State Approval: 2358.1
- For any available Test Data, Section Properties or Load Tables, please visit our download section at www.mcelroymetal.com

Instaloc

Instaloc is a snap-together standing seam that features a 1" seam and is installed with concealed clips. Instaloc is an excellent selection for applications where greater uplift characteristics are required than achieved with Meridian.

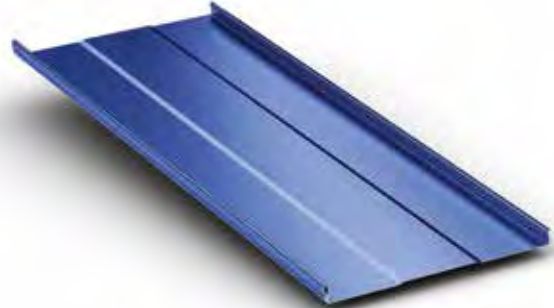
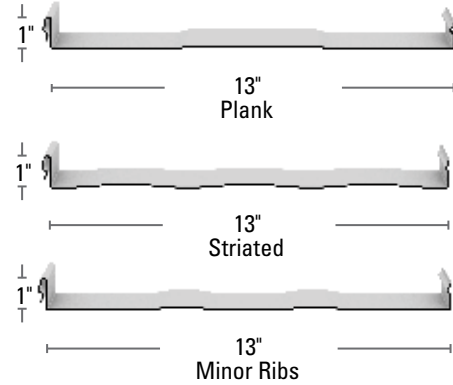

Instaloc Clip

Seam Detail



Details

- Minimum Slope: 3:12
- Must be installed over solid deck
- Factory applied sealant
- Instaloc is produced in Houston, TX

Panel Options

- Panel width: 13"
- Panel configurations: striated, plank and minor rib (striated recommended)
- Coating: Kynar 500® (PVDF)
- Substrate: Standard 24 gauge Galvalume

Testing Data

- Fire Rating: Class A
- Uplift Test: UL580 Class 90, UL 1897
- Class 4 Impact Resistance: UL 2218
- Texas Department of Insurance Approval: RC-86

Standing Seam Systems



Medallion I

Medallion I is an architectural standing seam system featuring a narrow batten cap applied over roofing panels and concealed clips. Medallion I is installed over solid deck and can also be curved to meet radius panel specifications.

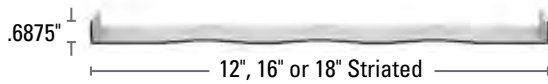

Medallion II

Medallion II is an architectural standing seam system that features a 1 1/2" wide batten cap applied over roofing panels and concealed clips. Medallion II is installed over solid deck.

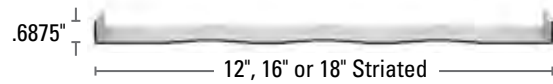

*Cover width is pan width plus 1"

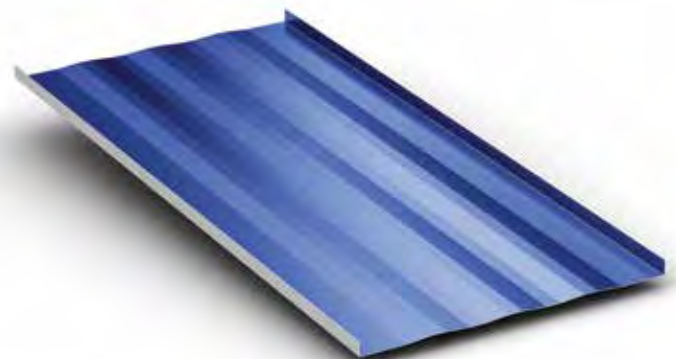
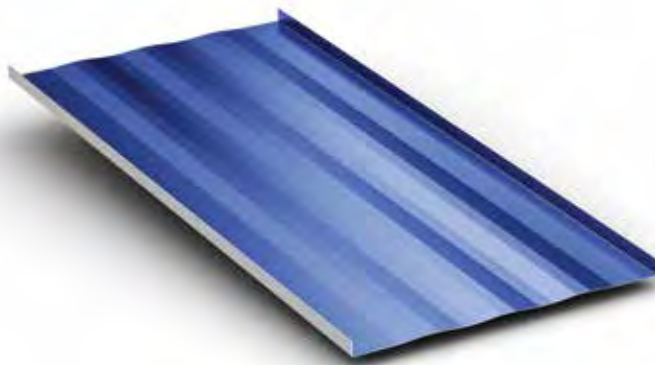

Medallion I Batten



Medallion I Clip

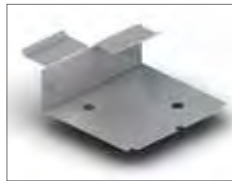

Medallion II Batten

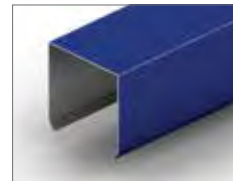

Medallion II Clip



Details

- Minimum slope: 3:12
- Must be installed over solid deck

Curving Details

- Minimum radius: 30"

Panel Options

- Panel width: 12", 16" and 18"
- Panel configurations: striated (recommended), ribbed, or flat pan
- Coating: Kynar 500® (PVDF)
- Substrate:
 - Standard 24 gauge Galvalume®

Testing Data

- Fire Rating: Class A
- Uplift Test: UL580 Class 90
- Air Infiltration: ASTM E1680
- Water Infiltration: ASTM E1646
- Class 4 Impact Resistance: UL 2218
- Florida State Approval: 1832.5
- Fire Resistance: UL 263
- For any available Test Data, Section Properties or Load Tables, please visit our download section at www.mcelroymetal.com

Details

- Minimum slope: 3:12
- Must be installed over solid deck

Panel Options

- Panel width: 12", 16" and 18"
- Panel configurations: striated (recommended), ribbed, or flat pan
- Coating: Kynar 500® (PVDF)
- Substrate:
 - Standard 24 gauge Galvalume

Testing Data

- Fire Rating: Class A
- Uplift Test: UL580 Class 90
- Air Infiltration: ASTM E1680
- Water Infiltration: ASTM E1646
- Class 4 Impact Resistance: UL 2218
- Florida State Approval: 1832.6
- Fire Resistance: UL263
- For any available Test Data, Section Properties or Load Tables, please visit our download section at www.mcelroymetal.com

Mirage

Mirage is a concealed fastener roofing panel with 1 5/8" high ribs spaced 8" on center. Mirage can be installed over solid deck or substructural members.

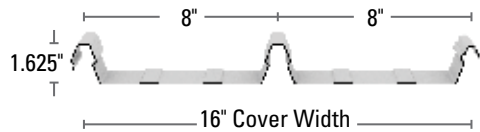

Mirage Clip



Seam Detail



Mirage II

Mirage II is a concealed fastener roofing panel with 1 3/4" high ribs spaced 8" on center. Mirage II can be installed over solid deck or substructural members.

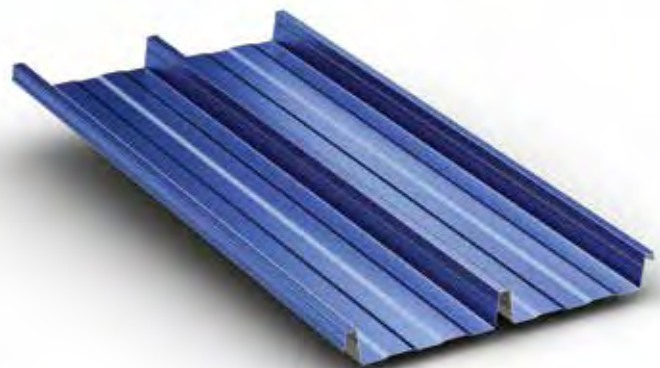
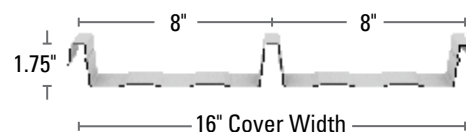

Mirage II Clip



Seam Detail



Mirage Details

- Minimum slope: 1/4:12
- Factory applied sealant is required on slopes less than 3:12
- Can be installed over solid deck or open framing
- Mirage is also available with Moisture-Lok
- Mirage is produced in Adelanto, CA

Panel Options

- Panel width: 16"
- Panel configurations: ribbed
- Coating: Kynar 500® (PVDF)
- Substrate:
 - Standard 24 gauge Galvalume®

Testing Data

- Fire Rating: Class A
- Uplift Test: UL580 Class 90 ASTM E1592
- Air Infiltration: ASTM E1680
- Water Infiltration: ASTM E1646
- Class 4 Impact Resistance: UL 2218
- Florida State Approval: 1747.7, 1832.9
- IAPMO Approval: ER-0270
- Fire Resistance: UL263
- For any available Test Data, Section Properties or Load Tables, please visit our download section at www.mcelroymetal.com

Mirage II Details

- Minimum slope: 1/4:12
- Factory applied sealant is required on slopes less than 3:12
- Can be installed over solid deck or open framing
- Mirage II is produced in Bossier City, LA and Ashburn, GA

Panel Options

- Panel width: 16"
- Panel configurations: ribbed
- Coating: Kynar 500® (PVDF)
- Substrate:
 - Standard 24 gauge Galvalume

Testing Data

- Fire Rating: UL790 Class A
- Uplift Test: UL580 Class 90
- Impact: UL2218 Class 4

MasterLok-90

MasterLok-90 is a snap-together trapezoidal standing seam system designed for projects with slopes as low as 1:12. MasterLok-90 is best suited for simple sloped roofs without dormers, hips, valleys or other special conditions. MasterLok-90 is installed over solid deck or substructural members.

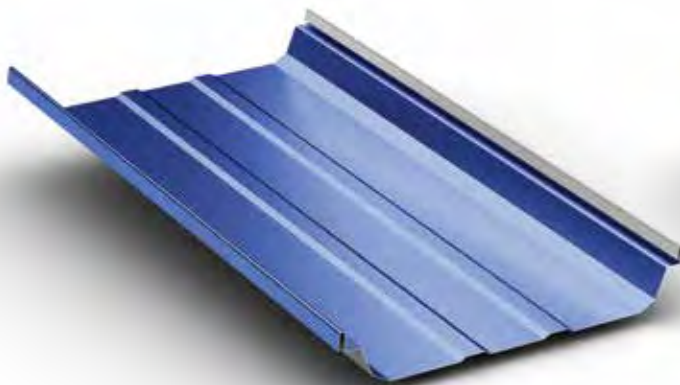

ML-90 Low Floating Clip



Seam Detail



Other utility, fixed, and floating clips available

MasterLok-90 Details

- Factory applied sealant in seam to improve weather-tightness
- Minimum slope: 1/4:12
- Can be installed over solid deck or open framing

Panel Options

- Panel width: 24"
- Coating: Kynar 500® (PVDF)
- Substrate:
 - Standard 24 gauge Galvalume®
 - Optional 22 gauge Galvalume
- Also available with Moisture-Lok

Testing Data

- Fire Rating: Class A
- Uplift Test: UL580 Class 90 ASTM E1592
- Air Infiltration: ASTM E1680
- Water Infiltration: ASTM E1646
- Class 4 Impact Resistance: UL 2218
- Florida State Approval: 1832.2, 1747.1
- For any available Test Data, Section Properties or Load Tables, please visit our download section at www.mcelroymetal.com

MasterLok-FS

MasterLok-FS is a mechanically seamed trapezoidal standing seam system designed for projects with slopes as low as 1/4:12. MasterLok-FS is best suited for simple sloped roofs without dormers, hips, valleys or other special conditions and can be installed over solid deck or substructural members.

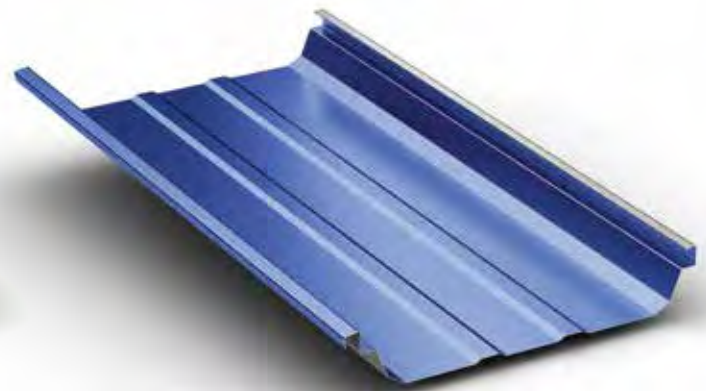

ML-FS Low Floating Clip



Before Seaming



After Seaming



Other floating clips available

MasterLok-FS Details

- Mechanically seamed profile
- Factory applied sealant in seam to improve weather-tightness
- Minimum slope: 1/4:12
- Can be installed over solid deck or open framing

Panel Options

- Panel width: 24"
- Coating: Kynar 500® (PVDF)
- Substrate:
 - Standard 24 gauge Galvalume
 - Optional 22 gauge Galvalume

Testing Data

- Fire Rating: Class A
- Uplift Test: UL580 Class 90 ASTM E1592
- Air Infiltration: ASTM E1680
- Water Infiltration: ASTM E1646
- Class 4 Impact Resistance: UL 2218
- Florida State Approval 8051.1
- For any available Test Data, Section Properties or Load Tables, please visit our download section at www.mcelroymetal.com

Soffit, Fascia & Canopy Panel



FW Panel

McElroy Metal's FW Panel features a 1.5" deep flush metal panel designed for usage in vertical applications. Available options include deep vee grooves, reveal 1/2" up to 3" in 1/2" increments, or a traditional smooth appearance. Regardless of the pattern, the 1.5" depth and the tongue-and-groove engagement remain the same.

Inverted Plank Profile

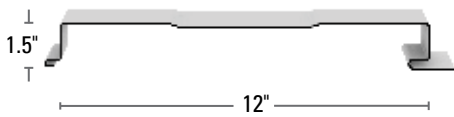

Flat

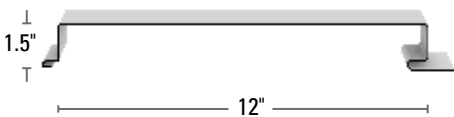

Vee Grooves

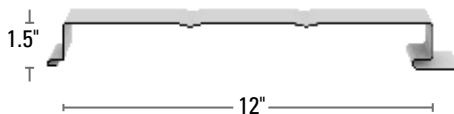

Reveal Options

Flush Panel Interlock



Typical 1 Reveal For 12" Panels



Custom Reveal For 12" Panels up to 3"



Details

- Maximum lengths:
 - 24 gauge 2' minimum and 8' maximum
 - 22 gauge 2' minimum and 15' maximum
- FW is produced in Houston, TX

Panel Options

- Panel width: 12"
- Panel configurations: inverted plank, flat, vee grooves

- Reveal Options:
 - 1" to 3" (panel remains at 12" and reveal size increases coverage)
- Coating: Kynar 500® (PVDF)
- Substrate:
 - Standard 24 gauge Galvalume®
 - Optional 22 gauge Galvalume

Testing Data

- Uplift Test: ASTM E1592
- FW Reveal: No testing

MCP

MCP (McElroy Canopy Panel) is a concealed fastener panel designed to meet the demands of canopy installations. Banks, drive-thru restaurants, convenience stores or any other building type requiring attractive and functional canopy systems are an excellent application for MCP.

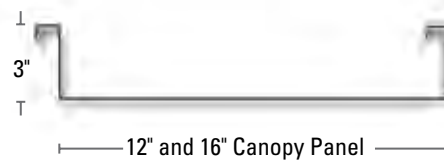

MCP Clip



Oil canning (pan wave) is a natural occurrence in metal panels and is not a cause for panel rejection.

Matrix 12" and Matrix 16"

Matrix soffit systems will add an elegant touch to any commercial or residential project. Matrix panels are easy to install. And, to minimize on-site labor, McElroy Metal inventories 11.5" and 23.5" length panels.

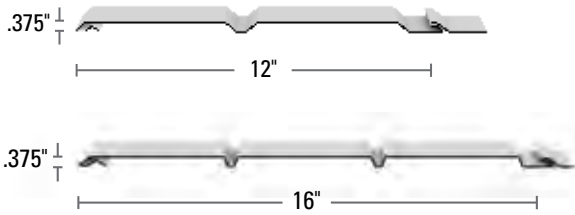

12" Panels

16" Panels

Details

- Stocked lengths: 11.5" and 23.5"
- 10% net free area with vented surface
- Matrix 12" is produced in Lewisport, KY
- Matrix 16" is produced in Marshall, MI

Panel Options

- Panel width: 12" and 16"
- Panel configurations: non-vented or vented
- Coating: Matrix 12"
 - Acrylic Coated Galvalume® 24 gauge and 29 gauge
 - Kynar 500® (PVDF) 24 gauge and 29 gauge

- Matrix 16"
 - Acrylic Coated Galvalume® 26 gauge and 29 gauge
 - Kynar 500® (PVDF) 26 gauge
 - Siliconized Polyester 29 gauge
- Substrate:
 - Standard Matrix 12" 24 gauge and 29 gauge Galvalume®
 - Standard Matrix 16" 26 gauge and 29 gauge Galvalume®

Testing Data

- Uplift Test: ASTM E1592
- For any available Test Data, Section Properties or Load Tables, please visit our download section at www.mcelroymetal.com

Marquee-Lok and Marquee II

Marquee-Lok and Marquee II are soffit and fascia panels that are coated in colors matching McElroy's standing seam systems. The end result is assurance of an exact color match between roof system, soffit, fascia and wall panels.

McElroy Metal's Marquee-Lok panel features a unique locking design that adds strength and helps to prevent the panels from unlatching due to high suction force during a wind incident. No other panel in the industry features this type of locking mechanism.

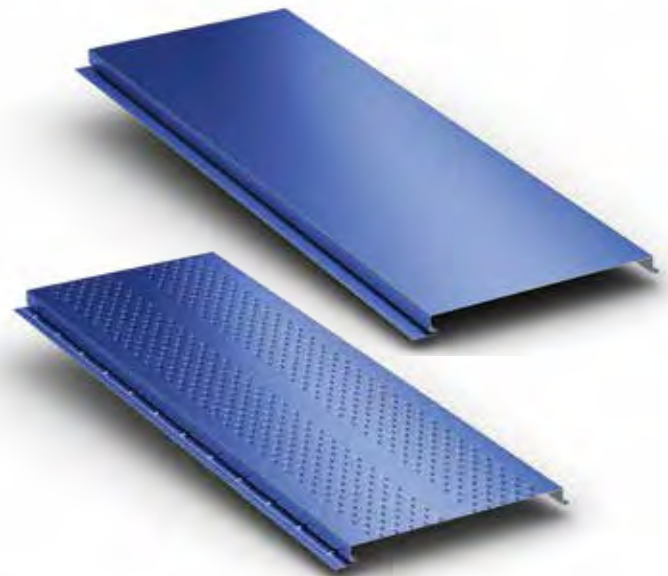
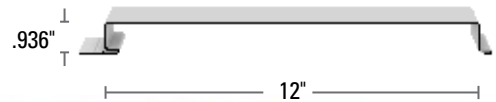

Details

- Marquee-Lok - 8% net free area with vented surface
- Marquee II - 2% net free area with vented surface
- Maximum lengths:
 - 24 GA and .032 aluminum is 8'
 - 22 GA is 15'
- Marquee-Lok is produced in Clinton, IL and Peachtree City, GA
- Marquee II is produced in Adelanto, CA

Testing Data

- Uplift Test: ASTM E1592 (Marquee-Lok with locking feature only)
- For any available Test Data, Section Properties or Load Tables, please visit our download section at www.mcelroymetal.com

Panel Options

- Panel width: 12"
- Marquee-Lok panel configurations:
 - Non-vented: flat or double pencil ribs (on-center spacing with double pencil ribs is 4")
 - Vented: flat or single pencil rib
- Marquee II panel configurations:
 - Non-vented: flat, single rib or double pencil ribs
 - Vented: flat or single pencil rib (vented available in 24 gauge only)
- Coating: Kynar 500® (PVDF)
- Substrate:
 - Standard 22 gauge Galvalume
 - Optional 24 gauge Galvalume

Concealed Fastener Wall Panel



Pre-Notched Wave Flashing

Wave pre-notched transition flashings allow for thermal expansion and contraction while providing an attractive finishing detail. Also available, Wave's pre-notched corner flashing



Wave

Available in both fixed and floating systems, McElroy Metal's Wave panels are concealed fastener wall panels that can be installed vertically or horizontally over solid substrate or subframing. Wave Fixed is installed with Wave's integral fastening flange which is roll formed into the panel during the manufacturing process and can be utilized for panel lengths of 40' or less. Wave Floating panels utilize separate clips and should be specified for panel lengths of 40' or greater.

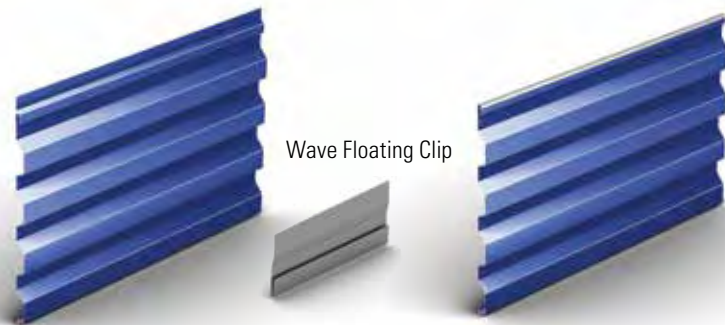
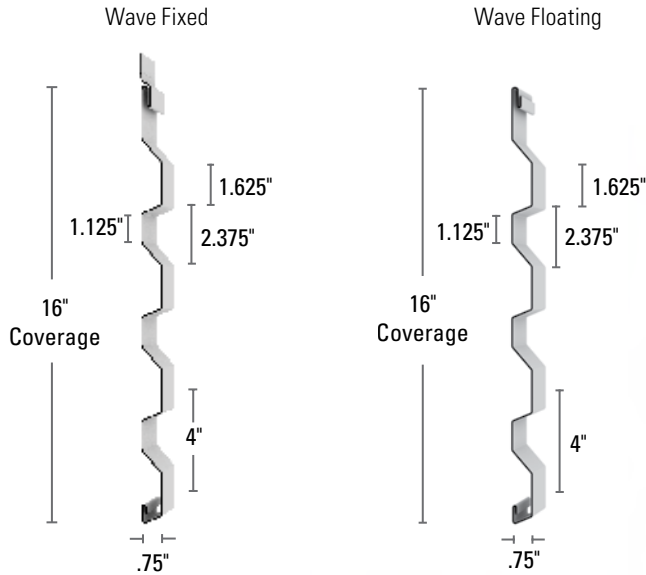

MSR

MSR is a concealed fastener wall panel by McElroy Metal that combines aesthetics and strength in one panel. MSR's bold profile will add curb appeal to most any project while providing the engineering and weather tightness characteristics demanded by architects and owners.

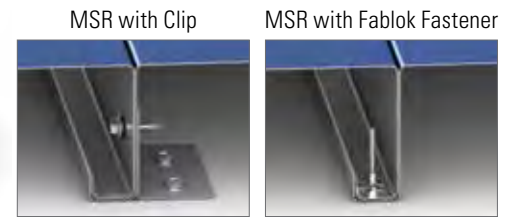
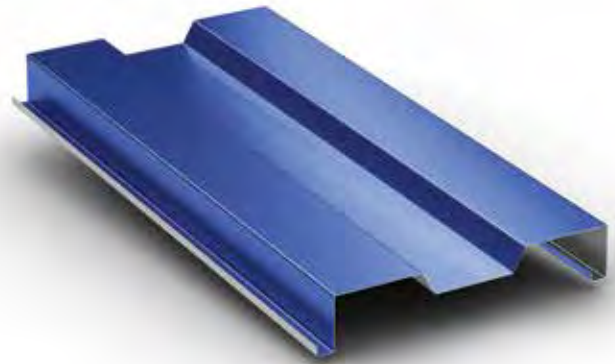
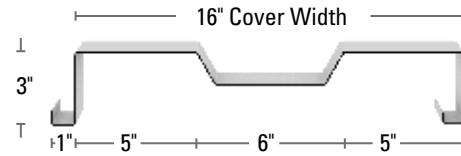

Details

- Concealed fastener wall panel
- Typically installed horizontally, but can be installed vertically
- Wave Fixed used for panel lengths 40' or less
- Wave Fixed has a concealed fastening flange
- Wave Floating used for panel lengths greater than 40'
- Wave Floating utilizes a clip
- Can be installed over solid deck or open framing
- Wave is produced in Houston, TX

Panel Options

- Panel width: 16"
- Coating: Kynar 500® (PVDF)
- Substrate: Standard 24 Gauge Galvalume®
Optional 22 gauge Galvalume

Testing Data

- Uplift Test: ASTM E1592
- For any available Test Data, Section Properties or Load Tables, please visit our download section at www.mcelroymetal.com

Details

- Concealed fastener wall panel for use with Fablok fasteners or angle clips
- Also called "Shadow Rib" panel
- MSR is produced in Sunnyvale, TX

Panel Options

- Panel width: 16"
- Panel height: 3"
- Maximum panel length: 50'
- Coating: Kynar 500® (PVDF)

- Substrate:
 - Standard 24 gauge Galvalume
 - Optional 22 gauge Galvalume

Testing Data

- Air Infiltration: ASTM E283
- Water Penetration: ASTM E331
- Acoustical Performance: ASTM E90
- For any available Test Data, Section Properties or Load Tables, please visit our download section at www.mcelroymetal.com

Exposed Fastener Panels



Mega-Rib

Mega-Rib is a 7.2 panel that provides optimum strength and spanning capabilities. Mega-Rib is equally well suited for industrial and commercial applications.

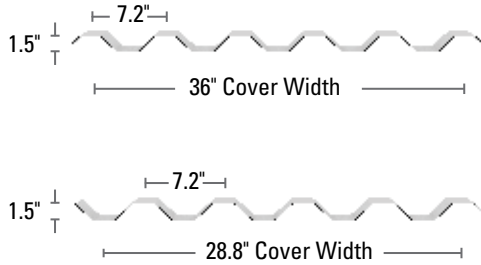

Note: Mega-Rib is also available with a 28.8" coverage, which is standard for 26 gauge panels. Please specify if 36" coverage is required.



Multi-Cor & M-Cor

McElroy's corrugated panels were designed and engineered with greater-than-normal spans and load-carrying characteristics in mind. And, they quickly communicate their high-strength performance capabilities. McElroy's Multi-Cor and M-Cor are similar in design, with M-Cor offering a more subtle rib height and configuration.

Multi-Cor



M-Cor



Details

- Minimum slope: 1:12
- Tape sealant required on all slopes
- Adelanto standard coverage for 26 gauge is 36" All other locations, standard 26 gauge coverage is 28.8" specify if 36" coverage is required
- Can be installed vertically or horizontally

Panel Options

- Coating: Kynar 500® (PVDF)
- Substrate:
 - Standard 24 gauge Galvalume®
 - Optional 22 gauge Galvalume
 - Optional 26 gauge Galvalume (narrow coverage)
 - Optional 26 gauge Galvalume (full coverage Adelanto only)

- Optional 18 and 20 gauge (painted Galvalume) (limited availability)

Testing Data

- Fire Rating: Class A
- Uplift Test: UL580 Class 90
- Air Infiltration: ASTM E1680
- Water Infiltration: ASTM E1646
- Class 4 Impact Resistance: UL2218
- Florida State Approval: 1832.8, 1747.6
- Fire Resistance: UL263
- Miami Dade Approval: NOA# 15-1013.06
- ICC-ES Approval: ESR-5896
- For any available Test Data, Section Properties or Load Tables, please visit our download section at www.mcelroymetal.com

Details

- Multi-Cor minimum slope: 1:12
- M-Cor minimum slope: 1:12
- Tape Sealant required on all slopes
- Multi-Cor and M-Cor can be installed over solid deck or open framing
- Multi-Cor and M-Cor are produced in Bossier City, LA

Panel Options

- Coating:
 - Kynar 500® (PVDF)
 - Silicone Modified Polyester (SMP)
- Substrate:
 - Standard 26 gauge Galvalume
 - Multi-Cor is also available in 24 and 22 gauge Galvalume
 - M-Cor is also available in 29 and 24 gauge Galvalume

Testing Data

- Fire Rating: Class A
- Uplift Test: UL580 Class 90 (Multi-Cor only)
- Class 4 Impact Resistance: UL 2218
- Florida State Approval: 10680.1 (Multi-Cor only)
- Texas Department of Insurance Approval: Evaluation RC-158 (Multi-Cor only)
- For any available Test Data, Section Properties or Load Tables, please visit our download section at www.mcelroymetal.com

Oil canning (pan wave) is a natural occurrence in metal panels and is not a cause for panel rejection.

Exposed Fastener Panels



Max-Rib

Max-Rib is a low profile 3/4" panel that is well suited for post frame, commercial, and residential applications.

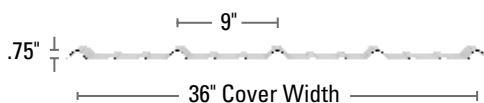

Details

- Minimum slope: 1:12 (with sealant)
- Minimum slope: 3:12 (without sealant)
- Also available with Moisture-Lok
- Class 4 Impact Resistance: UL 2218
- Florida State Approval: 1747.2, 1832.3
- Fire Resistance: UL263
- Texas Department of Insurance Approval: Evaluation RC-157
- For any available Test Data, Section Properties or Load Tables, please visit our download section at www.mcelroymetal.com

Testing Data

- Fire Rating: Class A
- Uplift Test: UL580 Class 90

Mesa

Mesa is a patent and copyright protected panel that features a nearly invisible lap. Designed for Post Frame and residential applications, Mesa will add beauty to any project.

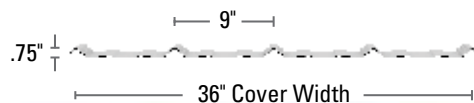

Details

- Minimum slope: 1:12 (with sealant)
- Minimum slope: 3:12 (without sealant)
- Patent and copyright protected
- Nearly invisible lap
- Ideal for post frame structures and residential roofing
- Also available with Moisture-Lok

5V

Homeowners across the country are discovering that metal roofing not only adds value to their home, but provides beauty as well. McElroy's 5V panel incorporates a classic design that will add beauty to any residential or commercial project.



Details

- Minimum slope: 3:12 with sealant
- 5V must be installed over solid decking
- 5V is produced in Ashburn, GA and Merkel, TX
- Class 4 Impact Resistance: UL 2218
- Florida State Approval: 1832.1
- Fire resistance: UL263
- Texas Department of Insurance: RC-13
- Miami Dade Approval: NOA# 13-0430.05
- For any available Test Data, Section Properties or Load Tables, please visit our download section at www.mcelroymetal.com

Testing Data

- Fire Rating: Class A
- Uplift Test: UL580 Class 90

U-Panel

U-Panel is an exposed fastener wall and roof panel that is also used extensively as a liner or partition panel.

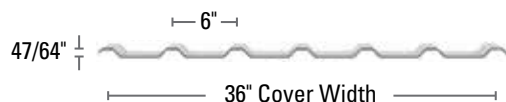

Note: Also available, U-Panel with non-purlin bearing leg

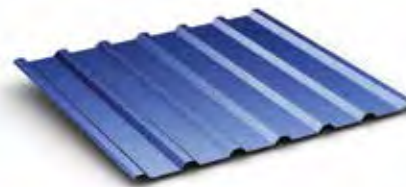

Details

- Minimum slope: 2:12 with sealant
- Fire Resistance: UL263
- For any available Test Data, Section Properties or Load Tables, please visit our download section at www.mcelroymetal.com

Testing Data

- Fire Rating: Class A
- Uplift Test: UL580 Class 90
- Class 4 Impact Resistance: UL 2218
- Florida State Approval: 8885.1
- IAPMO Approval: ER-0270

Oil canning (pan wave) is a natural occurrence in metal panels and is not a cause for panel rejection.

Exposed Fastener Panels

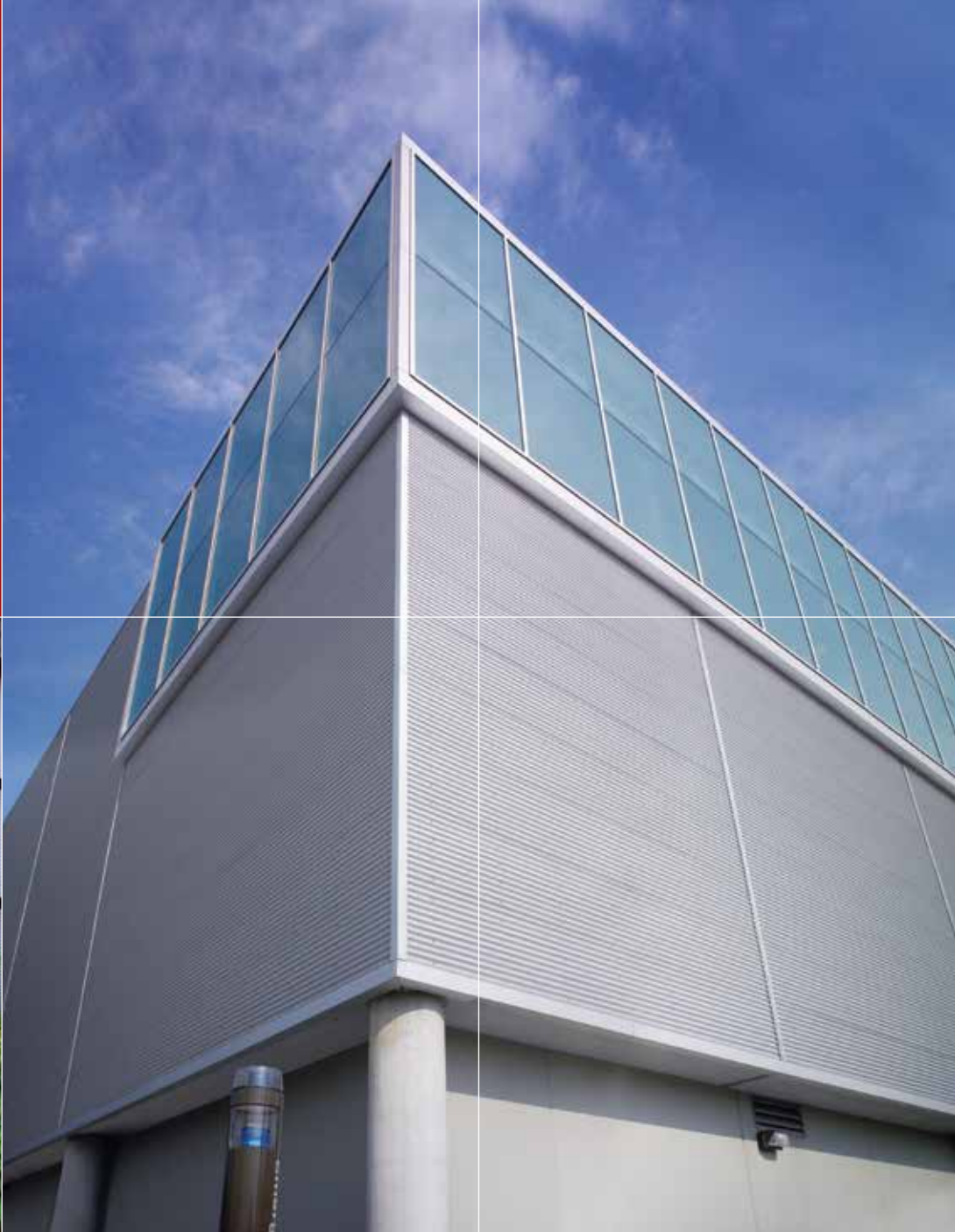

R-Panel

R-Panel is a multi-use roof and wall panel used primarily in pre-engineered metal building applications.

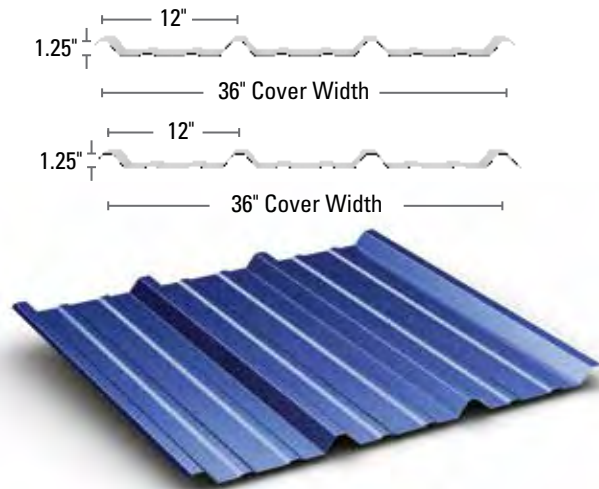

Details

- Minimum slope: 1:12 (with sealant)

Testing Data

- Fire Rating: Class A
- Uplift Test: UL580 Class 90, ASTM E1592 (24 GA PBR only)
- Air Infiltration: ASTM E1680
- Water Infiltration: ASTM E1646
- Class 4 Impact Resistance: UL 2218

- Florida State Approval: 1747.9, 1832.11
- Fire Resistance: UL263
- Miami Dade Approval: - NOA #17-0829.04 (roof - 24 gauge min. PBR) - NOA #17-0829.05 (wall - 24 gauge min. PBR)
- Texas Department of Insurance Approval: RC-284 (PBR only)
- For any available Test Data, Section Properties or Load Tables, please visit our download section at www.mcelroymetal.com

Multi-Rib

Multi-Rib is a multi-use roof and wall panel used primarily in pre-engineered metal building applications.

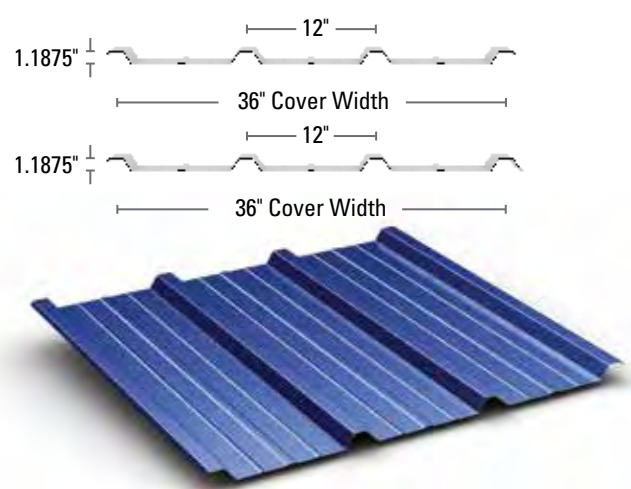

Details

- Minimum slope: 1:12 (with sealant)
- Also available with Moisture-Lok

Testing Data

- Fire Rating: Class A
- Uplift Test: UL580 Class 90, ASTM E1592 (26 PBR)
- Air Infiltration: ASTM E1680
- Water Infiltration: ASTM E1646

- Class 4 Impact Resistance: UL 2218
- Florida State Approval: 1747.8, 1832.10
- Fire Resistance: UL263
- Texas Department of Insurance Approval: Evaluation RC-63 and RC-283
- For any available Test Data, Section Properties or Load Tables, please visit our download section at www.mcelroymetal.com

Mini-Rib

The symmetrical design of McElroy's Mini-Rib panel makes it an appealing profile for wall, soffit, liner, and fascia applications.

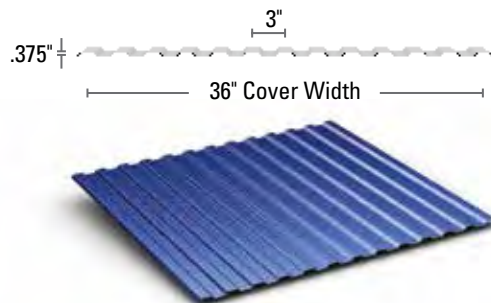

Details

- Mini-Rib is produced in Bossier City, LA

Testing Data

- For any available Test Data, Section Properties or Load Tables, please visit our download section at www.mcelroymetal.com

Multi-V

Multi-V is an exposed fastener wall panel that is designed so that fasteners are placed in the valleys, making them visually less apparent.

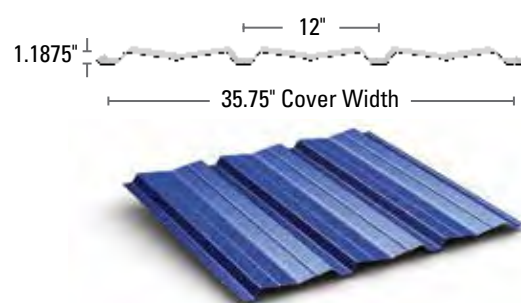

Testing Data

- For any available Test Data, Section Properties or Load Tables, please visit our download section at www.mcelroymetal.com

Oil canning (pan wave) is a natural occurrence in metal panels and is not a cause for panel rejection.

Met-Tile
& Milan



Met-Tile

Met-Tile roofing panels provide the appearance of ceramic tile roofing with all the advantages and performance of metal. Met-Tile is lightweight, energy efficient and aesthetically attractive. Since Met-Tile is a panelized roofing system, installation takes a fraction of the time required for ceramic tiles. Panels are installed vertically from eave to ridge and are secured to the deck with fasteners.



Kynar 500® Colors



Note: Colors are representative of colors offered and are not intended for matching purposes.

Details

- Minimum slope: 1 1/2:12 required with sealant
- Minimum slope: 3:12 required without sealant
- Must be installed over solid deck
- Met-Tile is produced in Sunnyvale, TX

Panel Options

- Panel lengths: 2' - 20' (in 1' increments)

- Panel width: 38 5/16"
- Panel coverage: 36 3/16"
- Steps are 1' OC
- Coating: low gloss, Kynar 500® (PVDF)
- Substrate: - 26 gauge Galvalume® stucco embossed only

Testing Data

- Fire Rating: Class A
- Florida State Approval: 17905.1

Milan

Milan shingles add beauty and curb appeal to any home or business. Offering eight attractive Kynar 500® colors as well as Slate and Shake Kynar 500 Prints, McElroy Metal's Milan will compliment any exterior design palette.

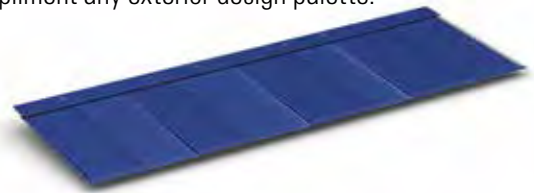

Kynar 500® Colors

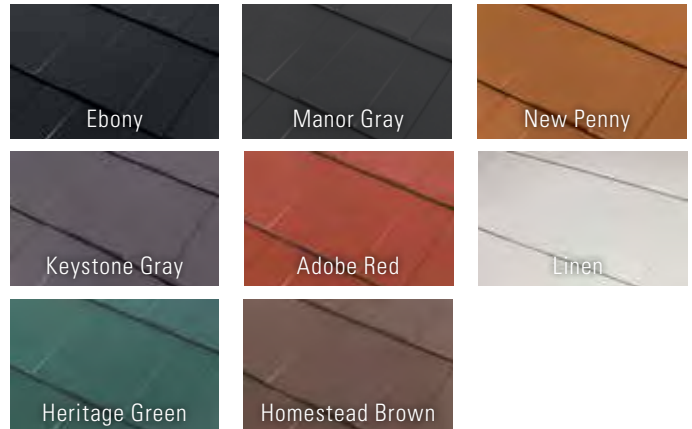

Kynar 500® Designer Prints



Note: Colors are representative of colors offered and are not intended for matching purposes.

Details

- Minimum Slope 3:12
- Panel exposure: 39" x 12"
- Panels per square: 30.77
- Continuous integrated nailing flange
- Four-way interlock system secured to the roof using aluminum fastening clips
- Can be installed over most existing asphalt shingles or solid deck

Testing Data

- Florida State Approval: 19173.1

Panel Options

- Weight per square: 76 lbs
- Coating: - Kynar 500® (PVDF) - Designer prints in Kynar 500® (PVDF) also available
- Substrate: - 29 gauge G90 Galvanized steel

Retrofit Systems



Retrofit Systems

McElroy Metal has the optimal solution for building owners, architects and contractors who desire a high performance, long-term solution for worn-out conventional roofs. McElroy Metal Retrofit Roofing Systems provides an extended service life and reduced life-cycle costs. In many cases, the cost difference between a conventional roof tear-off and replacement compared to a retrofit metal roof system is a return on investment which can be recovered in a short period of time.

Building Owner Benefits

- Decades long service life
- Reduced maintenance
- Energy savings through reduced consumption
- Aids in LEED™ certification
- Increases wind and snow storm resistance
- Possible reduction of insurance premiums
- Improves appreciable value of your building

The Contractor's Advantages

- Easy to erect framing systems
- Designed by in-house McElroy Metal engineering staff
- Proven and tested standing seam metal roofing systems
- All materials manufactured by McElroy Metal
- Quicker than normal turn-around times
- Reduces landfill expenses for disposal of existing materials

McElroy Metal Retrofit Roofing Systems are engineered to adapt to the existing roof's structural support system whether constructed of steel, concrete or wood.

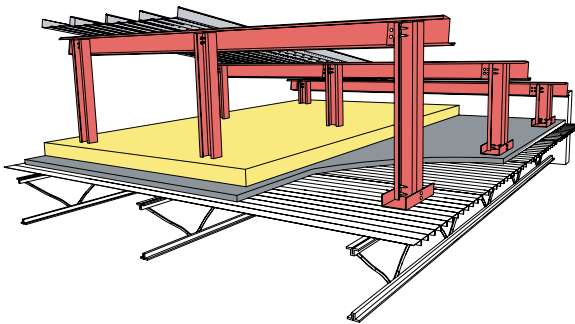

Adaptation to Steel

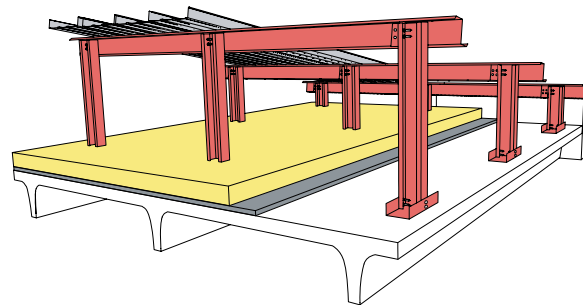

Adaptation to Concrete

Substructural Components

McElroy's substructural components - Cees, Zees, Hats, Channels, Angles - represent the broadest selection of cold-formed substructural components in the industry. McElroy's new XL line adds capabilities down to 10 gauge and up to 24" web widths.

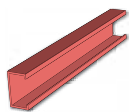

CEE

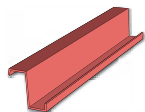

ZEE

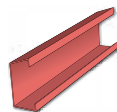

EAVE STRUT

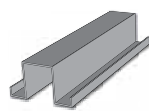

HAT

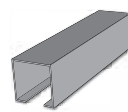

CHANNEL

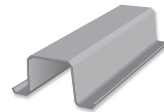

MAC-GIRT

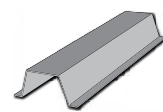

SUB-GIRT

Cee, Zee, and Eave Strut are available in 12, 14, and 16 gauge.

Hat, Channel, Mac-Girt, and Sub-Girt are available in 16, 18, and 20 gauge.

Solar Solutions



McElroy Metal Peachtree City, GA manufacturing plant with McElroy 238T panels and Crystalline solar panels.

Solar Solutions

McElroy Metal roofing panels are frequently the host material for crystalline and thin-film solar technologies. The end-result is a functional and environmentally friendly roof system that generates renewable, clean, green energy.

Crystalline panels are the most popular photovoltaic product and offer higher efficiency and power generation. Crystalline Panels are easily attached to McElroy Metal standing seam systems utilizing S-5! PV Kits, which hold the solar panels in place without penetrating the roof.

Thin-film solar laminate solar panels are flexible and adhere directly to many McElroy Metal standing seam systems. Because the solar material is adhered directly to the roof panels, this technology is referred to as Building Integrated Photovoltaic (BIPV). Thin-film solar panels are lightweight, aesthetically appealing, and have an ability to generate power under cloudy conditions.



S-5! PV Kit

Crystalline Panels



Thin-film Solar Laminate



Green Span Profiles



Green Span Profiles

Green Span Profiles (GSP) is a McElroy Metal joint venture company that manufactures Insulated Metal Panels (IMP's) in a state-of-the-art manufacturing facility in Waller, TX.

Insulated Metal Panels are premier building products on the leading edge of innovation. Panels are formed by a continuous poured-in-place manufacturing process which binds interior and exterior steel facings to a polyisocyanurate insulating foam core. Green Span Profiles GSPs offer exceptional insulating properties (R = 8 per inch), superior spanning, superior spanning capability, accelerated installation times and an attractive architectural appearance. GSP wall panels can be installed both vertically and horizontally.

Green Span Profiles are available in 2, 2.5, 3, 4, 5, and 6 inch thickness.

Green Span's RidgeLine roof panel features a 238T symmetrical standing seam, making it the industry's easiest IMP to install. RidgeLine is available with a 42" cover width in thicknesses from 2 1/2" to 5".

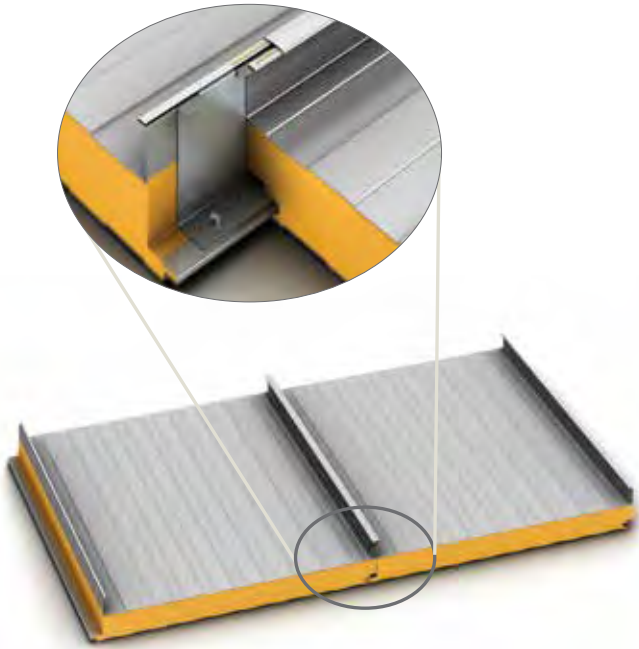

Ridgeline

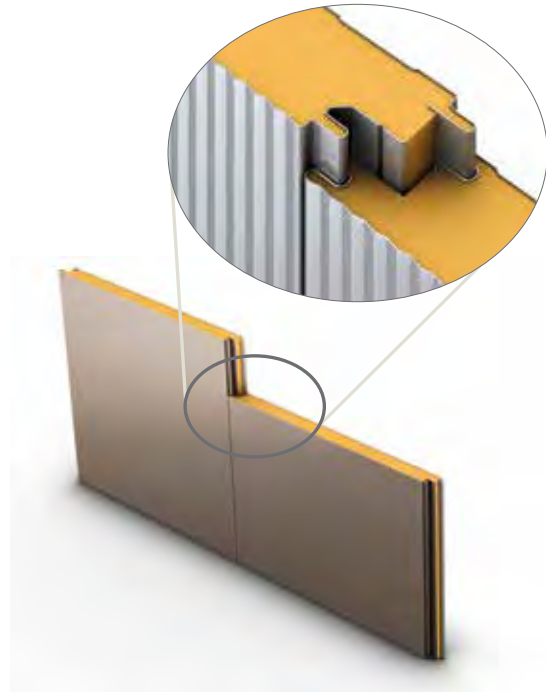

Waveline



Mesaline



Shadowline



Impression

Slit Coils, Flat Sheets, & Perforated

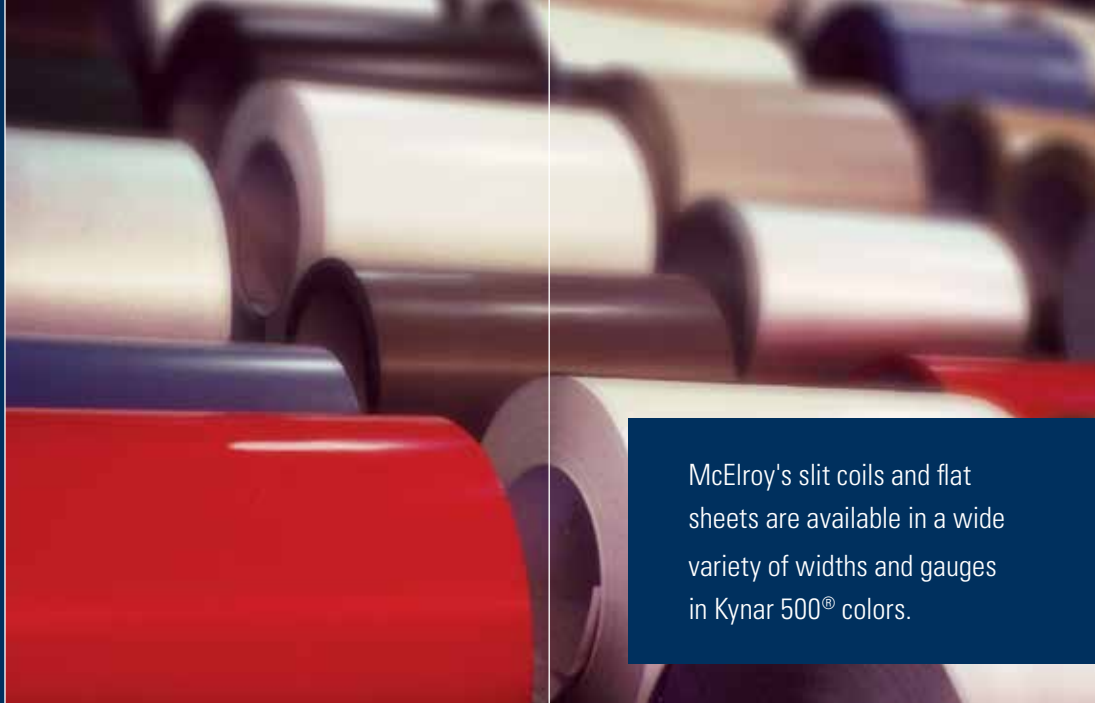

McElroy's slit coils and flat sheets are available in a wide variety of widths and gauges in Kynar 500® colors.



This five-story parking garage in Austin, Texas was created with custom colors on perforated panels from McElroy Metal.



address:
1500 Hamilton RD.
Bossier City, LA 71111

phone:
318.747.8000
fax:
318.747.8029

email:
info@mcelroymetal.com
web:
www.mcelroymetal.com